

5G Ethernet Modem

IDG450-0GE0C (5G NR)

User Manual



5G Ethernet Modem

Chapter 1 Introduction	4
1.1 Introduction.....	4
1.2 Contents List	5
1.2.1 Package Contents	5
1.3 Hardware Configuration.....	7
1.4 LED Indication	8
1.5 Installation & Maintenance Notice	8
1.5.1 SYSTEM REQUIREMENTS	8
1.5.2 WARNING	9
1.5.3 HOT SURFACE CAUTION	11
1.5.4 Product Information for CE RED Requirements	12
1.6 Hardware Installation.....	16
1.6.1 Mount the Unit.....	16
1.6.2 Insert the SIM Card.....	16
1.6.3 Connecting to the Network or a Host.....	17
1.6.4 Setup by Configuring WEB UI	17
Chapter 2 Setup	18
2.1 Network	18
2.1.1 Device Mode.....	18
2.1.2 Cellular	19
2.1.3 Ethernet	21
2.1.4 Port Forwarding	22
2.1.5 DDNS.....	25
2.2 System	25
2.2.1 System Time	25
2.2.2 Language	27
2.2.3 System Information	27
2.2.4 Scheduling	27
Chapter 3 Administrator	29
3.1 Manager	29
3.1.1 FW Upgrade.....	29
3.1.2 Password & MMI.....	30
3.1.3 Reboot & Reset.....	31

5G Ethernet Modem

- 3.1.4 SSH..... 32
- 3.1.5 Remote Administrator 32

Chapter 1 Introduction

1.1 Introduction

Congratulations on your purchase of AMIT IDG450 M2M 5G Modem. With this AMIT 5G modem you have made a great first step in the world of connected Internet of things (IOT) by simply inserting a SIM card from the local mobile carrier into this device to get things connected. This section gives you all the information you need to set up your device.

Main Features:

- Provide 5G WAN connection and is back compatible with 3G/4G.
- Provide one 2.5 Gigabit Ethernet port for the LAN connection.
- Instinctive Web GUI is used for basic setting and check the cellular status.
- Designed easy-to-mount metal body for business and M2M environment to work with a variety M2M (Machine-to-Machine) applications.

Before you install and use this product, please read this manual in detail for fully exploiting the functions of this product.

5G Ethernet Modem

1.2 Contents List

1.2.1 Package Contents

#Standard Package

Items	Description	Contents	Quantity
1	IDG450-0GE0C 5G Ethernet Modem		1pc
2-1	Cellular Antenna-Japan		4pcs
2-2	Cellular Antenna-Taiwan		4pcs
3	RJ45 Cable		1pc
4	USB Type C Cable(1M)		1pc

#Optional Package

Items	Description	Contents	Quantity
1	USB AC Power adapter for JP, TW, USA		SB310-0520 <ul style="list-style-type: none"> ●AC INPUT: 100-240V ●DC OUTPUT: 5V 2A ●DC PLUG: USB ●Dimension:42.1*34.7*22mm ●SAFETY: PSE, UL, CE ●Working Temperature : -20°C~ -60°C (5V 1.2A)
2	USB AC Power adapter for TW, USA, EU		PA1015-0501B240 <ul style="list-style-type: none"> ●AC INPUT: 100-240V ●DC OUTPUT: 5V 2.4A ●DC PLUG: USB ●Dimension:68*43*55.8mm ●SAFETY: PSE, UL, CE,FCC ●Working Temperature : 0°C~ 40°C

5G Ethernet Modem

3	USB AC Power Adapter with Core for TW, USA, EU		PS1010-050HIB200 <ul style="list-style-type: none"> ●AC INPUT: 100-240V ●DC OUTPUT: 5V 2A ●DC PLUG: USB ●Dimension:67*42.5*49.4mm ●SAFETY: UL, CE, FCC ●Working Temperature : 0°C~ -40°C
2	Wall mount kit		<p style="text-align: center;">1 set (L-shaped iron piece: screw x 4 IDG450 housing: screw x4)</p>
3	DIN rail kit		<p style="text-align: center;">1 set (DIN rail: screw x3 IDG450 housing: screw x2)</p>

5G Ethernet Modem

1.3 Hardware Configuration

➤ Right View

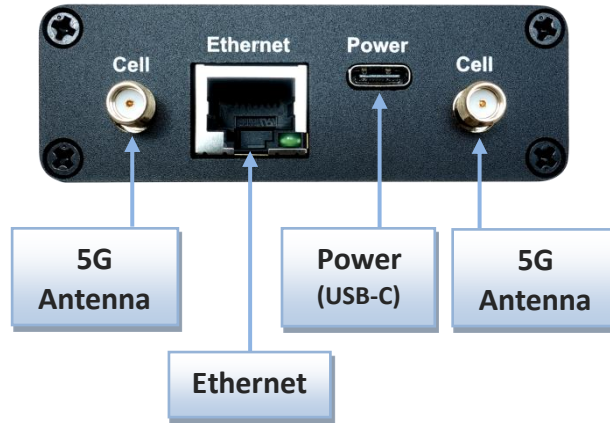

➤ RightView

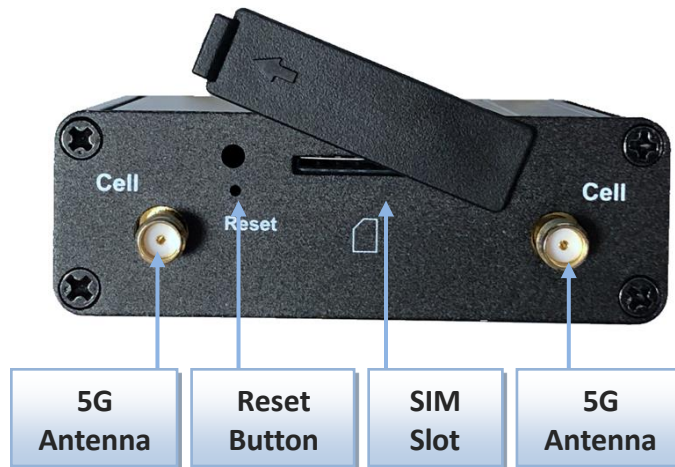



⌘ Reset Button

RESET button provides user a quick and easy way to resort the default setting. Press the RESET button continuously for 6 seconds, and then release it. The device will restore to factory default settings.

5G Ethernet Modem

1.4 LED Indication



Indication	LED Color	Description
 Power	Blue	Steady On: Device power is on Off: Device power is off
 Cell/PDP	Blue Red	Red and Steady On: Cellular is not registered to network. Red and Flash: Cellular is registering to network. Blue and Steady On: The device registers to 5G network. Blue and Slow Flash: The device registers to LTE or 3G network.
 Signal Strength	Blue	Blue and Steady On: Cellular signal is good. Blue and Slow Flash: Cellular signal is weak. OFF: No cellular signal.

1.5 Installation & Maintenance Notice

1.5.1 SYSTEM REQUIREMENTS

Network Requirements	<ul style="list-style-type: none">• Ethernet RJ45 cable• 4G/5G cellular service subscription• 100/1000M Ethernet adapter on PC
Web-based Configuration Utility Requirements	<p>Computer with the following:</p> <ul style="list-style-type: none">• Windows®, Macintosh, or Linux-based operating system• An installed Ethernet adapter <p>Browser Requirements:</p> <ul style="list-style-type: none">• Internet Explorer 8.0 or higher• Chrome 2.0 or higher• Firefox 3.0 or higher• Safari 3.0 or higher

5G Ethernet Modem

1.5.2 WARNING



Attention

- Only use the power adapter that comes with the package. Using a different voltage rating power adaptor is dangerous and may damage the product.
- Do not open or repair the case yourself. If the product is too hot, turn off the power immediately and have it repaired at a qualified service center.
- Place the product on a stable surface and avoid using this product and accessories outdoors.

5G Ethernet Modem

Federal Communication Commission Interference Statement

This device complies with Part 15 of the FCC Rules. Operation is subject to the following two conditions: (1) This device may not cause harmful interference, and (2) this device must accept any interference received, including interference that may cause undesired operation.

This equipment has been tested and found to comply with the limits for a Class B digital device, pursuant to Part 15 of the FCC Rules. These limits are designed to provide reasonable protection against harmful interference in a residential installation. This equipment generates uses and can radiate radio frequency energy and, if not installed and used in accordance with the instructions, may cause harmful interference to radio communications. However, there is no guarantee that interference will not occur in a particular installation. If this equipment does cause harmful interference to radio or television reception, which can be determined by turning the equipment off and on, the user is encouraged to try to correct the interference by one of the following measures:

- Reorient or relocate the receiving antenna.
- Increase the separation between the equipment and receiver.
- Connect the equipment into an outlet on a circuit different from that to which the receiver is connected.
- Consult the dealer or an experienced radio/TV technician for help.

FCC Caution: Any changes or modifications not expressly approved by the party responsible for compliance could void the user's authority to operate this equipment.

This transmitter must not be co-located or operating in conjunction with any other antenna or transmitter.

FOR PORTABLE DEVICE USAGE (<20m from body/SAR needed)

Radiation Exposure Statement:

The product complies with the FCC portable RF exposure limit set forth for an uncontrolled environment and are safe for intended operation as described in this manual. The further RF exposure reduction can be achieved if the product can be kept as far as possible from the user body or set the device to lower output power if such function is available.

FOR MOBILE DEVICE USAGE (>20cm/low power)

Radiation Exposure Statement:

This equipment complies with FCC radiation exposure limits set forth for an uncontrolled environment. This equipment should be installed and operated with minimum distance 20cm between the radiator & your body.

FOR COUNTRY CODE SELECTION USAGE (WLAN DEVICES)

Note: The country code selection is for non-US model only and is not available to all US model. Per FCC regulation, all WiFi product marketed in US must be fixed to US operation channels only.

5G Ethernet Modem

1.5.3 HOT SURFACE CAUTION



CAUTION: The surface temperature for the metallic enclosure can be very high! Especially after operating for a long time, installed at a closed cabinet without air conditioning support, or in a high ambient temperature space.

DO NOT touch the hot surface while servicing!!

5G Ethernet Modem

1.5.4 Product Information for CE RED Requirements

The following product information is required to be presented in product User Manual for latest CE RED requirements.¹

(1) Frequency Band & Maximum Power

1.a Frequency Band for 5G NR /4G LTEConnection (for RM520N-GL version)²

Band number	Operating Frequency	Max output power
5G NR bands (n1/n2/n3/n5/n7/n8/n12/n13/n14/ n20/n25/n26/n28/n29/n30/n48/n66/ n71/n75/n76/)	N1 Uplink: 1920-1980 MHz Downlink: 2110-2170 MHz N2 Uplink: 1850-1910 MHz Downlink: 1930-1990 MHz N3 Uplink: 1710-1785 MHz Downlink: 1805-1880 MHz N5 Uplink: 824-849 MHz Downlink: 869-894 MHz N7 Uplink: 2500-2570 MHz Downlink: 2620-2690 MHz N8 Uplink: 880-915 MHz Downlink: 925-960 MHz N12 Uplink: 699-716MHz Downlink: 729-746MHz N13 Uplink: 777-787MHz Downlink: 746-756MHz N14 Uplink: 788-798MHz Downlink: 758-768MHz N20 Uplink: 832-862 MHz Downlink: 791-821 MHz N25 Uplink: 1850-1915 MHz Downlink: 1930-1995 MHz N26 Uplink: 814-849 MHz Downlink: 859-894 MHz N28 Uplink: 703-748 MHz Downlink: 758-803 MHz N29 Downlink: 711-728 MHz N30 Uplink: 2305-2315 MHz Downlink: 2350-2360 MHz N48 Uplink: 3550-3700MHz Downlink: 3550-3700MHz	23±2 dBm

¹ The information presented in this section is ONLY valid for the EU/EFTA regional version. For those non-CE/EFTA versions, please refer to the corresponding product specification.

² There can be different cellular module integrated in the device for EU/EFTA regional version. Refer to the cellular module identifier printed on the device label for the purchased device.

5G Ethernet Modem

	<p>N66 Uplink: 1710-1780MHz Downlink: 2110-2200MHz</p> <p>N71 Uplink: 663-698MHz Downlink: 617-652MHz</p> <p>N75 Downlink: 1432-1517MHz</p> <p>N76 Downlink: 1427-1432MHz</p>	
<p>LTE & 5G NR HUPPE Bands (n38/n40/n41/n77/n78/n79)</p>	<p>N38 Uplink: 2570-2620MHz Downlink: 2570-2620MHz</p> <p>N40 Uplink: 2300-2400MHz Downlink: 2300-2400MHz</p> <p>N41 Uplink: 2496-2690MHz Downlink: 2496-2690MHz</p> <p>N77 Uplink: 3300-4200MHz Downlink: 3300-4200MHz</p> <p>N78 Uplink: 3300-3800MHz Downlink: 3300-3800MHz</p> <p>N79 Uplink: 4400-5000MHz Downlink: 4400-5000MHz</p>	<p>26+2/-3 dBm</p>
<p>LTE Bands</p>	<p>B1 Uplink: 1920-1980 MHz Downlink: 2110-2170 MHz</p> <p>B2 Uplink: 1850-1910 MHz Downlink: 1930-1990 MHz</p> <p>B3 Uplink: 1710-1785 MHz Downlink: 1805-1880 MHz</p> <p>B4 Uplink: 1710-1755 MHz Downlink: 2110-2155 MHz</p> <p>B5 Uplink: 824-849 MHz Downlink: 869-894 MHz</p> <p>B7 Uplink: 2500-2570 MHz Downlink: 2620-2690 MHz</p> <p>B8 Uplink: 880-915 MHz Downlink: 925-960 MHz</p> <p>B12 Uplink: 699-716MHz Downlink: 729-746MHz</p> <p>B13 Uplink: 777-787MHz Downlink: 746-756MHz</p> <p>B14 Uplink: 788-798MHz Downlink: 758-768MHz</p> <p>B17 Uplink: 699-716MHz Downlink: 729-746MHz</p> <p>B18 Uplink: 815-830MHz Downlink: 860-875MHz</p> <p>B19 Uplink: 830-845MHz Downlink: 875-890MHz</p> <p>B20 Uplink: 832-862 MHz</p>	<p>23 ±2 dBm</p>

5G Ethernet Modem

	Downlink: 791-821 MHz B25 Uplink: 1850-1915 MHz Downlink: 1930-1995 MHz B26 Uplink: 814-849 MHz Downlink: 859-894 MHz B28 Uplink: 703-748 MHz Downlink: 758-803 MHz B29 Downlink: 711-728 MHz B30 Uplink: 2305-2315 MHz Downlink: 2350-2360 MHz B32 Downlink: 1452-1496 MHz B48 Uplink: 3550-3700MHz Downlink: 3550-3700MHz B66 Uplink: 1710-1780MHz Downlink: 2110-2200MHz B71 Uplink: 663-698MHz Downlink: 617-652MHz B75 Downlink: 1432-1517MHz B76 Downlink: 1427-1432MHz	
LTE HPUE Bands (B38/B41/B42/B43)	B38 Uplink: 2570-2620MHz Downlink: 2570-2620MHz B41 Uplink: 2496-2690MHz Downlink: 2496-2690MHz B42 Uplink: 3400-3600MHz Downlink: 3400-3600MHz B43 Uplink: 3600-3800MHz Downlink: 3600-3800MHz	26±2 dBm
WCDMA BANDs	B1 Uplink: 1920-1980 MHz Downlink: 2110-2170 MHz B2 Uplink: 1850-1910 MHz Downlink: 1930-1990 MHz B4 Uplink: 1710-1755 MHz Downlink: 2110-2155 MHz B5 Uplink: 824-849 MHz Downlink: 869-894 MHz B8 Uplink: 880-915 MHz Downlink: 925-960 MHz B19 Uplink: 830-845MHz Downlink: 875-890MHz	24+1/-3 dBm

(2) DoC Information

You can get the DoC information of this product from the following

URL: <http://www.amitwireless.com/products-doc/>

5G Ethernet Modem

(3) RF Exposure Statements

To comply with RF exposure limits established in FCC, the distance between the antenna or antennas and the user should not be less than 20 cm (7.87”).

(4) Unit Mounting Notice

The product is suitable for mounting at heights $\leq 2\text{m}$ (approx. 6 ft), or in a cabinet.

Ensure the unit is fixed tightly to reduce the likelihood of injury due to exposure to mechanical hazards if dropped.

(5) Manufacture Information

Manufacture Name: AMIT Wireless Inc.

Manufacture Address: No. 28, Lane 31, Sec. 1, Huandong Rd., Sinshih Dist., Tainan 74146, Taiwan

5G Ethernet Modem

1.6 Hardware Installation

This chapter describes how to install and configure the hardware

1.6.1 Mount the Unit

The IDG450 series can be placed on a desktop, or use extender to place on DIN-Rail bracket or mount on the wall.

1.6.2 Insert the SIM Card

WARNING: BEFORE INSERTING OR CHANGING THE SIM CARD, PLEASE MAKE SURE THAT POWER OF THE DEVICE IS SWITCHED OFF.

SIM card slot is located in the middle area of IDG450 series. You need to remove the outer SIM card cover before installing or removing an inserted SIM card. Please follow below instructions to install or remove a SIM card. After SIM card is well installed or removed, put back the outer SIM card cover.

Step 1: Remove SIM cover

Remove the SIM cover from left side.



Step 3: Insert a SIM

Push the SIM card into the SIM slot.



Step 4: Put Back SIM cover

Put back the SIM cover



5G Ethernet Modem

1.6.3 Connecting to the Network or a Host

The IDG450 series provides one RJ45 port to connect to 10/100/1000/2500Mbps Ethernet. It can auto detect the transmission speed on the network and configure itself automatically. Connect one Ethernet cable to the RJ45 port (LAN) of the device and plug another end of the Ethernet cable into your computer's network port to connect this device to the host PC for device configuration.

1.6.4 Setup by Configuring WEB UI

You can browse web UI to configure the device.

Type in the IP Address (<http://192.168.123.254>)³

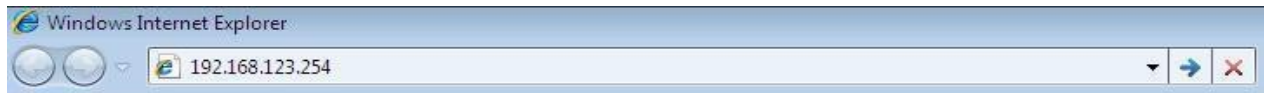

When you see the login page, enter the user name and password and then click '**Login**' button.

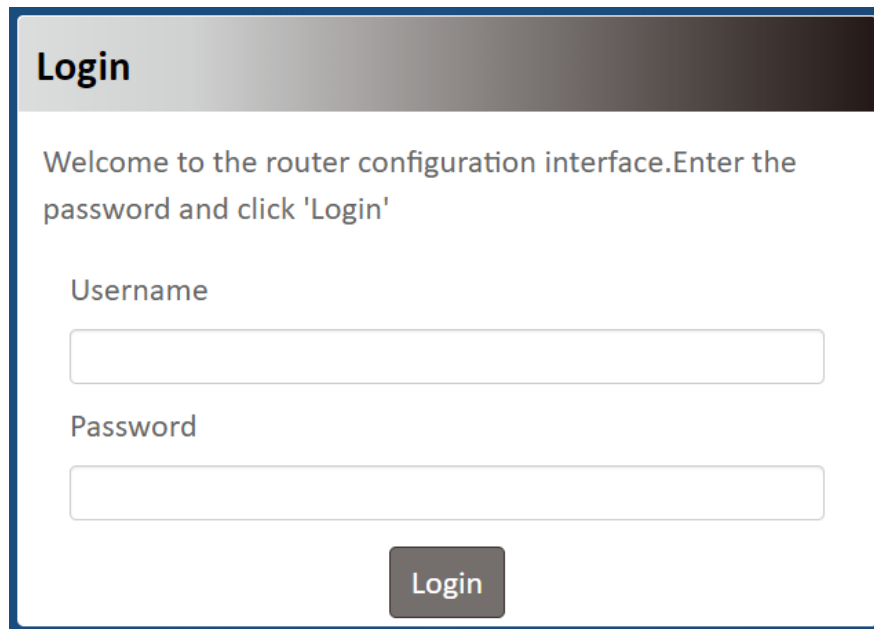
A screenshot of a web-based login interface for a router configuration. The page has a dark grey header with the word "Login" in white. Below the header, there is a message: "Welcome to the router configuration interface. Enter the password and click 'Login'". There are two input fields: one labeled "Username" and one labeled "Password". At the bottom center of the form is a dark grey button with the word "Login" in white text.

The default setting for both username and password is '**admin**'⁴.

³ The default LAN IP address of this gateway is 192.168.123.254. If you change it, you need to login by using the new IP address.

⁴ For security concern, the login process will force user to change default password at the first time.

5G Ethernet Modem

Chapter 2 Set up

The IDG450 series connect to a machine via the Ethernet interface for 3G/4G/5G network connection. IDG450 series also provides another function with NAT router. It can help the network application more flexible.

2.1 Network

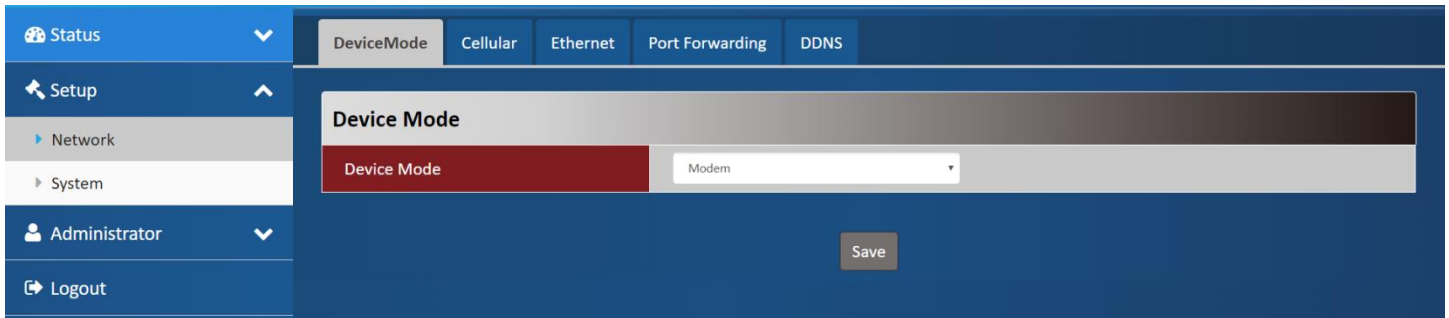

Network Page Item	Description
Device Mode	Set the unit operating mode
Cellular	Set the parameter for cellular network.
Ethernet	Set the IP of Ethernet and DHCP service
Port Forwarding	Enable specified port or protocol for service on connected device.
DDNS	Register a dynamic host name for the unit.

2.1.1 Device Mode

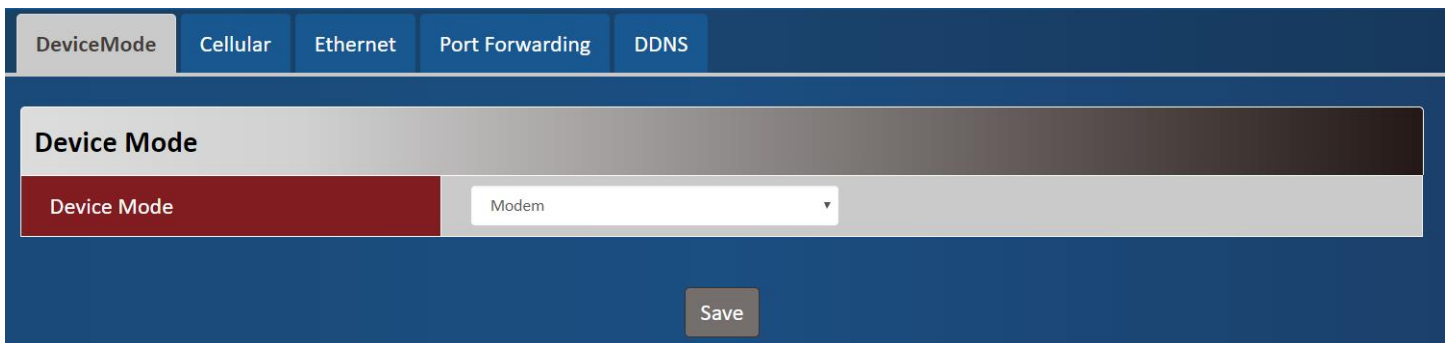

Device Mode Item	Value setting	Description
Device Mode	1. A Must filled setting 2. By default NAT is selected	NAT The unit will provide a NAT service and provide a simple firewall for the connected device. Modem The unit will pass the cellular IP to connected device via ethernet

5G Ethernet Modem

2.1.2 Cellular

Device Mode
Cellular
Ethernet
Port Forwarding
DDNS

Cellular Access

APN	<input type="text" value="Manual"/>
Manual APN	<input type="text"/>
Username	<input type="text"/>
Password	<input type="text"/>
Authentication	<input type="text" value="Auto"/>
IP Type	<input type="text" value="IPv4"/>
IP Mode	<input type="text" value="Dynamic IP"/> <input type="button" value="Static IP Config"/>
PIN Code	<input type="text"/>
MTU Setup	<input type="checkbox"/> Enable <input type="text" value=""/> (68~1500)
Keep Alive	<input type="checkbox"/> Enable IP Address : <input type="text" value="8.8.8.8"/> Interval : <input type="text" value="60"/> (2~14400 seconds)
Roaming	<input type="checkbox"/> Enable
Discard Ping from WAN	<input type="checkbox"/> Enable

Device Mode Item	Value setting	Description
APN	1. A Must filled setting 2. By default Auto is selected	Auto The unit will detect the SIM and set an APN from internal database. Manual User must set APN manually.
Manual APN	1. A Must filled setting 2. String format : any text	Enter the APN you want to use to establish the connection. This is a must-filled setting if you selected Manual APN as APN scheme.
Username	1. An Optional setting 2. String format : any text	Enter the optional username settings if your ISP provided such settings to you.
Password	1. An Optional setting 2. String format : any text	Enter the optional Password settings if your ISP provided such settings to you.
Authentication	1. A Must filled setting 2. By default Auto is selected	Select PAP (Password Authentication Protocol) and use such protocol to be authenticated with the carrier's server. Select CHAP (Challenge Handshake Authentication Protocol) and use such

5G Ethernet Modem

		protocol to be authenticated with the carrier's server. When Auto is selected, it means it will authenticate with the server either PAP or CHAP .
IP Type	1. A Must filled setting 2. By default IPv4 is selected	Specify the IP type of the network service provided by your 3G/4G network. It can be IPv4 , IPv6 , or IPv4v6 .
IP Mode	1. A Must filled setting 2. By default Dynamic IP is selected	Dynamic IP The unit will get IP from cellular service.. Static IP The unit will set IP according Static IP Config .
PIN Code	1. An Optional setting 2. String format : interger	Enter the PIN (Personal Identification Number) code if it needs to unlock your SIM card.
MTU Setup	1. An Optional setting 2. Uncheck by default	Check the Enable box to enable the MTU (Maximum Transmission Unit) limit, and specify the MTU for the 3G/4G connection. MTU refers to Maximum Transmission Unit. It specifies the largest packet size permitted for Internet transmission. Value Range: 68 ~ 1500.
Keep Alive	1. An optional setting 2. Box is unchecked by default	Check the Enable box to activate the keep alive function. Input IP Address and interval to send an ICMP packet to check the network status.
Roaming	1. An Optional setting 2. Uncheck by default	Check the checkbox to enable the modem to connect on the cellular network at roaming state.
Discard Ping from WAN	1. An Optional setting 2. Uncheck by default	The modem will not respond the ICMP request packet from remote hosts when the checkbox is checked.

Static IP Configuration

IP	<input type="text" value="0.0.0.0"/>
Subnet Mask	<input type="text" value="255.255.255.0 (/24)"/>
Default Gateway	<input type="text" value="0.0.0.0"/> (Optional)
Primary DNS	<input type="text" value="0.0.0.0"/> (Optional)
Secondary DNS	<input type="text" value="0.0.0.0"/> (Optional)

Save Close

Static IP Configuration

Item	Value setting	Description
IP	1. IPv4 format. 2. A Must filled setting	The Static IP Address setting of this unit.
Subnet Mask	255.255.255.0 (/24) is set by default	The Subnet Mask of this configured static IP.

5G Ethernet Modem

Default Gateway	1. IPv4 format. 2. AnOptional setting	Thegateway setting ofthis configed static IP.
Primary DNS	1. IPv4 format. 2. AnOptional setting	Assigned DNS server of this configed static IP.
Secondary DNS	1. IPv4 format. 2. AnOptional setting	Assigned DNS server of this configed static IP.

2.1.3 Ethernet

DeviceMode
Cellular
Ethernet
Port Forwarding
DDNS

Ethernet IP

IP	<input type="text" value="192.168.123.254"/>
Netmask	<input type="text" value="255.255.255.0 (/24)"/>
DHCP Server	<input checked="" type="checkbox"/> Enable
DHCP Setting	DHCP Config

[Save](#)

Ethernet IP Item	Value setting	Description
IP	1. IPv4 format. 2. A Must filled setting	The LAN IP Address of this unit.
Netmask	255.255.255.0 (/24) is set by default	The Subnet Mask of this unit.
DHCP Server	The box is unchecked by default.	Click Enable box to activate DHCP Server.
DHCP Setting	N/A	Click DHCP Config button to pop-up the DHCP Setting page.

5G Ethernet Modem

DHCP Setting

IP Pool Start	<input style="width: 100%;" type="text" value="5"/>
IP Pool End	<input style="width: 100%;" type="text" value="10"/>
Lease Time	<input style="width: 100%;" type="text" value="3600"/>

Item	Value setting	Description
IP Pool Start	1. Numeric string format. 2. A Must filled setting	The IP Pool of this DHCP Server. It is Starting Address entered in this field.
IP Pool End	1. Numeric string format. 2. A Must filled setting	The IP Pool of this DHCP Server. It is Ending Address entered in this field.
Lease Time	1. Numeric string format. 2. A Must filled setting	The Lease Time of this DHCP Server. <u>Value Range:</u> 300 ~ 604800 seconds.

2.1.4 Port Forwarding

DeviceMode
Cellular
Ethernet
Port Forwarding
DDNS

Virtual Server

Virtual Server
 Enable

Item	Value setting	Description
Virtual Server	The box is unchecked by default	Check the Enable box to activate this port forwarding function Click Add will pop-up Virtual Server Rule Configuration page.

5G Ethernet Modem

Virtual Server Rule Configuration

Name	<input style="width: 100%;" type="text"/>
Server IP	<input style="width: 100%;" type="text"/>
Source IP	<input style="width: 100%;" type="text" value="Any"/>
Protocol	<input style="width: 100%;" type="text" value="TCP(6)"/>
Public Port	<input style="width: 100%;" type="text" value="Single Port"/> <input style="width: 50px;" type="text"/>
Private Port	<input style="width: 100%;" type="text" value="Single Port"/> <input style="width: 50px;" type="text"/>
Rule	<input type="checkbox"/> Enable

Virtual Server Rule Configuration		
Item	Value setting	Description
Name	1. String format can be any text 2. A Must filled setting	The name of current rule
Server IP	A Must filled setting	This field is to specify the IP address of the interface selected in the WAN Interface setting above.
Source IP	1. A Must filled setting 2. By default Any is selected	This field is to specify the Source IP address . Select Any to allow the access coming from any IP addresses. Select Specific IP Address to allow the access coming from an IP address. Select IP Range to allow the access coming from a specified range of IP address.
Protocol	A Must filled setting	When "TCP(6)" is selected It means the option "Protocol" of packet filter rule is TCP. Public Port selected a predefined port from Well-known Service , and Private Port is the same with Public Port number. Public Port is selected Single Port and specify a port number, and Private Port can be set a Single Port number. Public Port is selected Port Range and specify a port range, and Private Port can be selected Single Port or Port Range . <u>Value Range</u> :1 ~ 65535 for Public Port, Private Port. When "UDP(17)" is selected

5G Ethernet Modem

	<p>It means the option “Protocol” of packet filter rule is UDP. Public Port selected a predefined port from Well-known Service, and Private Port is the same with Public Port number. Public Port is selected Single Port and specify a port number, and Private Port can be set a Single Port number. Public Port is selected Port Range and specify a port range, and Private Port can be selected Single Port or Port Range. <u>Value Range</u>:1 ~ 65535 for Public Port, Private Port.</p> <p>When “TCP(6)& UDP(17)” is selected It means the option “Protocol” of packet filter rule is TCP and UDP. Public Port selected a predefined port from Well-known Service, and Private Port is the same with Public Port number. Public Port is selected Single Port and specify a port number, and Private Port can be set a Single Port number. Public Port is selected Port Range and specify a port range, and Private Port can be selected Single Port or Port Range. <u>Value Range</u>:1 ~ 65535 for Public Port, Private Port.</p> <p>When “User-defined” is selected It means the option “Protocol” of packet filter rule is User-defined. For Protocol Number, enter a port number.</p>
<p>Rule</p> <p>1. An optional filled setting 2. The box is unchecked by default.</p>	<p>Check the Enable box to activate the rule.</p>

Rule Name

test

Virtual Server – Rule Name		
Item	Value setting	Description
Rule name	N/A	Click “ Edit ” button to pop-up Virtual Server Rule Configuration page to edit the rule. Click “ Delete ” button to delete this rule

5G Ethernet Modem

2.1.5 DDNS

The screenshot shows the DDNS configuration interface. At the top, there are navigation tabs: DeviceMode, Cellular, Ethernet, Port Forwarding, and DDNS. The DDNS tab is selected. Below the tabs is a 'Configuration' section with the following fields:

- DDNS:** A checkbox labeled 'Enable' which is currently unchecked.
- Provider:** A dropdown menu with 'DynDNS.org' selected.
- Host Name:** An empty text input field.
- User Name / E-Mail:** An empty text input field.
- Password / Key:** An empty text input field.

A 'Save' button is located at the bottom center of the configuration area.

DDNS Item	Value setting	Description
DDNS	The box is unchecked by default	Check the Enable box to activate this function.
Provider	DynDNS.org is set by default	Select your DDNS provider of Dynamic DNS. It can be DynDNS.org, NO-IP.com, TZO.com etc...
Host Name	1. String format can be any text 2. A Must filled setting	Your registered host name of DDNS Service. <i>Value Range:0 ~ 63 characters.</i>
User Name / E-Mail	1. String format can be any text 2. A Must filled setting	Enter your User name or E-mail address of DDNS Service.
Password / Key	1. String format can be any text 2. A Must filled setting	Enter your Password or Key of DDNS Service.

2.2 System

This section provides the configuration of system features.

2.2.1 System Time

5G Ethernet Modem

System Time	Language	System Information	Scheduling
System Time			
Current Time	Fri Jan 1 01:17:07 2021		
Sync Time	Auto		
Time Zone	(GMT+00:00) Greenwich Mean Time: Dublin, Edinburgh, Lisbon, London		
NTP Server	pool.ntp.org		
Daylight Saving	<input type="checkbox"/> Enable		
Start Date	1 / 1 / 0 (Month/Day/Year)		
End Date	1 / 1 / 0 (Month/Day/Year)		
Action	Action		

Device Mode Item	Value setting	Description
Current Time	N/A	Show the current time of the unit.
Sync Time	1. A Must-filled item. 2. Auto is selected by default.	When select Auto , unit will sync the time via cellular cell, and then try to use NTP if cellular cell doesn't provide time information. When select NTP , the unit will sync time via ntp service.
Time Zone	1. A Must-filled item. 2. GMT+00 :00 is selected by default.	Select a time zone where this device locates.
NTP Server	1. A Must-filled item.	Indicate which NTP server will be used of the time synchronization.
Daylight Saving	1. It is an optional item. 2. Un-checked by default	Check the Enable button to activate the daylight saving function. When user enabled this function, user has to specify the Start Date and End Date for the daylight saving time duration.
Start Date	N/A	Start time for Daylight Saving.
End Date	N/A	End Time of Daylight Saving.
Action	N/A	Click Action to sync time immediately

5G Ethernet Modem

2.2.2 Language

System Time | GNSS | **Language** | System Information | Scheduling

Configuration

Language List | English

Save

Language Item	Value setting	Description
Language List	1. A Must-filled item. 2. English is selected by default.	Language setting of the WebGUI.

2.2.3 System Information

System Time | Language | **System Information** | Scheduling

System Information

Model Name | IDG450-0GE01

System Information Item	Value setting	Description
Model Name	N/A	Show the model name of the device

2.2.4 Scheduling

System Time | GNSS | Language | System Information | **Scheduling**

Time Schedule

Time Schedule | Add

Scheduling Item	Value setting	Description
-----------------	---------------	-------------

5G Ethernet Modem

Time Schedule N/A Press **Add** to create a schedule rule for system.

Time Schedule Configuration

Rule Name	<input style="width: 100%;" type="text"/>
Rule Policy	<div style="border: 1px solid #ccc; padding: 2px; display: inline-block;">Inactivate ▼</div> The Selected Days and Hours Below.

Time Period Definition

Week Day	<div style="border: 1px solid #ccc; padding: 2px; display: inline-block;">Every Day ▼</div>
Start Time (hh:mm)	<input style="width: 100%;" type="text"/>
End Time (hh:mm)	<input style="width: 100%;" type="text"/>

Save

Close

Time Schedule Configuration		
Item	Value Setting	Description
Rule Name	String: any text	Set rule name
Rule Policy	Default Inactivate	Inactivate/activate the function been applied to in the time period below

Time Period Definition		
Item	Value Setting	Description
Week Day	Select from menu	Select everyday or one of weekday
Start Time	Time format (hh :mm)	Start time in selected weekday
End Time	Time format (hh :mm)	End time in selected weekday

Chapter 3 Administrator

3.1 Manager

3.1.1 FW Upgrade

Firmware Information		
Item	Value setting	Description
FW Version	N/A	It displays the firmware version of the product
FW Date	N/A	It displays the build time of the firmware

Firmware Upgrade		
Item	Value setting	Description
FW Path	N/A	Select firmware file to be upgraded
Upgrade Action	N/A	Click Upgrade button to start upgrade process with selected FW

Backup Configuration Settings		
Item	Value setting	Description
Backup Configuration Settings	N/A	Select Download to backup current configuration to a file. Select Upload to restore configuration from selected file.

5G Ethernet Modem

3.1.2 Password & MMI

FW Upgrade
Password & MMI
Reboot & Reset
SSH
Remote Administrator

Username

Username	admin
New Username	<input style="width: 100%;" type="text"/>

Save

Password

Old Password	<input style="width: 100%;" type="password"/>
New Password	<input style="width: 100%;" type="password"/>
New Password Confirmation	<input style="width: 100%;" type="password"/>

(NOTE: The password must be at least 10 characters long, and must contain at least 1 English letter and 1 number. The password cannot be the same as the login account.)

Save

MMI

Login	Password-Guessing Attack & MAX: <input style="width: 40px;" type="text" value="3"/> (times)
Login Timeout	<input checked="" type="checkbox"/> Enable <input style="width: 40px;" type="text" value="300"/> (seconds)

Username Item	Value setting	Description
Username	1. The default username is 'admin'.	Display the current username for the administrator
New Username	String: any text	Enter the new username
Save	N/A	Click Save button to save the settings

5G Ethernet Modem

Password Item	Value setting	Description
Old Password	1. String: any text 2. The default password for web-based MMI is 'admin'.	Enter the current password to enable you unlock to change password.
New Password	String: any text	Enter new password
New Password Confirmation	String: any text	Enter new password again to confirm
Save	N/A	Click Save button to save the settings

MMI Item	Value setting	Description
Login	3 times is set by default	Enter the login trial counting value. Value Range: 3 ~ 10. If someone tried to login the web GUI with incorrect password for more than the counting value, an warning message " Already reaching maximum Password-Guessing times, please wait a few seconds! " will be displayed and ignore the following login trials.
Login Timeout	The Enable box is checked, and 300 is set by default.	Check the Enable box to activate the auto logout function, and specify the maximum idle time as well. Value Range: 30 ~65535.

3.1.3 Reboot & Reset

Device Mode Item	Value setting	Description
Reboot	N/A	Click the Reboot button to reboot the unit immediately
Reset to Default	N/A	Click the Reset button to reset the device configuration to its default value.

5G Ethernet Modem

3.1.4 SSH

SSH Item	Value setting	Description
SSH	<ol style="list-style-type: none">Default value is disable such serviceBy default Service Port is 22.	<p>Check the Enable box to activate the SSH Telnet function for connecting from LAN or WAN interfaces.</p> <p>You can set which number of Service Port you want to provide for the corresponding service.</p> <p>Value Range: 1 ~65535.</p>

Configuration

SSH LAN Enable WAN Enable Service Port : 22

Save

3.1.5 Remote Administrator

Remote Administrator Host Definition Item	Value setting	Description
Remote Administrator Host Definition	N/A	Press "Add" to set a remote administrator rule

5G Ethernet Modem

Rule Configuration

Name	<input style="width: 90%;" type="text"/>
Protocol	<input style="width: 90%;" type="text" value="HTTP"/>
Remote IP	<input style="width: 60%;" type="text" value="Any IP"/> <input style="width: 35%;" type="text"/>
Subnet Mask	<input style="width: 90%;" type="text" value="255.0.0.0 (/8)"/>
Service Port	<input style="width: 90%;" type="text" value="80"/>
Rule	<input type="checkbox"/> Enable

Rule Configuration		
Item	Value setting	Description
Name	String: any text	Set rule name
Protocol	HTTP is set by default	Select HTTP or HTTPS method for router access.
Remote IP	A Must filled setting	This field is to specify the remote host to assign access right for remote access. Select Any IP to allow any remote hosts Select Specific IP to allow the remote host coming from a specific subnet.
Subnet Mask	N/A	An IP address entered in this field and a selected Subnet Mask to compose the subnet if Remote IP set in Specific IP .
Service Port	1. 80 for HTTP by default 2. 443 for HTTPS by default	This field is to specify a Service Port to HTTP or HTTPS connection. <u>Value Range:</u>1 ~ 65535.
Rule	The box is unchecked by default.	Click Enable box to activate this rule.